

BLANCO

Makes the difference

**Instructions
for the use and care
of your BDW 206
BDW 206 X
Dishwasher**

Contents

For the user

Important safety information	3
Description of the appliance	4
The control panel	5
Before use	6
Rinse aid	6
Use of detergent	7
Using your appliance	8
Loading your appliance	8
Adjusting the height of the upper basket	9
Hints and tips	10
Washing programmes	11
Operating sequence	12
Maintenance and cleaning	13
Internal cleaning	13
Cleaning the central filters	13
Cleaning the large filter	13
External cleaning	14
Prolonged periods of non-operation	14
Frost precautions	14
Moving the machine	14
Something not working	15
Service and spare parts	16
Sales information	22

For the installer

Installation instruction	17
Technical specifications	17
Water supply connections	18
Water outlet connection	19
Electrical connection	19
Adjusting the worktop	20
Fitting under a counter	20
Levelling	20
Fitting a decor panel on the door	21

Guide to use the instruction book

The following symbols will be found in the text to guide you throughout the instructions:



Safety instructions

1. 2. 3. Step by step instructions



Hints and tips



Important safety information

It is most important that this instruction book should be retained with the appliance for future reference. Should the appliance be sold or transferred to another owner, or should you move house and leave the appliance, always ensure that the book is left with the appliance in order that the new owner can get to know the functioning of the appliance and the relevant safety information.

This information has been provided in the interest of safety. You **MUST** read it carefully before installing or using the appliance.

Installation

- This appliance is heavy. Care should be taken when moving it.
- It is dangerous to alter the specifications or attempt to modify this product in any way.
- Care must be taken to ensure that the appliance does not stand on the electrical supply cable.
- Any electrical work required to install this appliance should be carried out by a qualified electrician or competent person.
- Any plumbing work required to install this appliance should be carried out by a qualified plumber or competent person.
- It is the responsibility of the installer to ensure that the inlet and outlet hoses not be bent or obstructed when the machine is installed. If either hose is bent or damaged upon installation it will not be covered by the warranty.

Child safety

- This appliance is designed to be operated by adults.
Children should not be allowed to tamper with the controls or play with the product.
- Keep all packaging well away for children.
- Keep all detergents in a safe place out of children's reach.

During use

- Items that are contaminated by petrol, paint, steel or iron debris, corrosive, acidic or alkaline chemicals must not be washed in this dishwasher.
- Under no circumstances should you open the door whilst the appliance is in operation. Always turn off the appliance before opening the door.
- Only use detergent specifically designed for use in dishwashers.
- When finishing loading or unloading close the door, as an open door can be a hazard.

- Do not sit or stand on the open door.
- Isolate the appliance from the power supply and turn off the water supply after use.
- Care should be taken when cleaning the bottom door seal and hinge area as any exposed metal edges may cut if care is not taken.
- This product should be serviced by an authorised Service engineer, and only genuine spare parts should be used.
- Under no circumstances should you attempt to repair the machine yourself. Repairs carried out by inexperienced or unauthorised persons may cause injury or serious malfunction **and will void the warranty**. Contact your local Service Force Centre. Always insist on genuine spare parts.

Conservation

In the interest of the environment:

- Materials marked with the symbol  are recyclable.
- Check with your local Council or Environmental Health Office to see if there are facilities in your area for re-cycling this appliance.
- When the appliance is to be scrapped, cut off the power supply cable and make the door closing device unusable to prevent young children from being trapped inside.
- Help to keep your country tidy - use authorised disposal sites for your old appliance.



Warning: Dishwasher detergents are strongly alkaline, they can be extremely dangerous if swallowed.

Avoid contact with skin and eyes and keep children away from the dishwasher when the door is open.

Description of the appliance

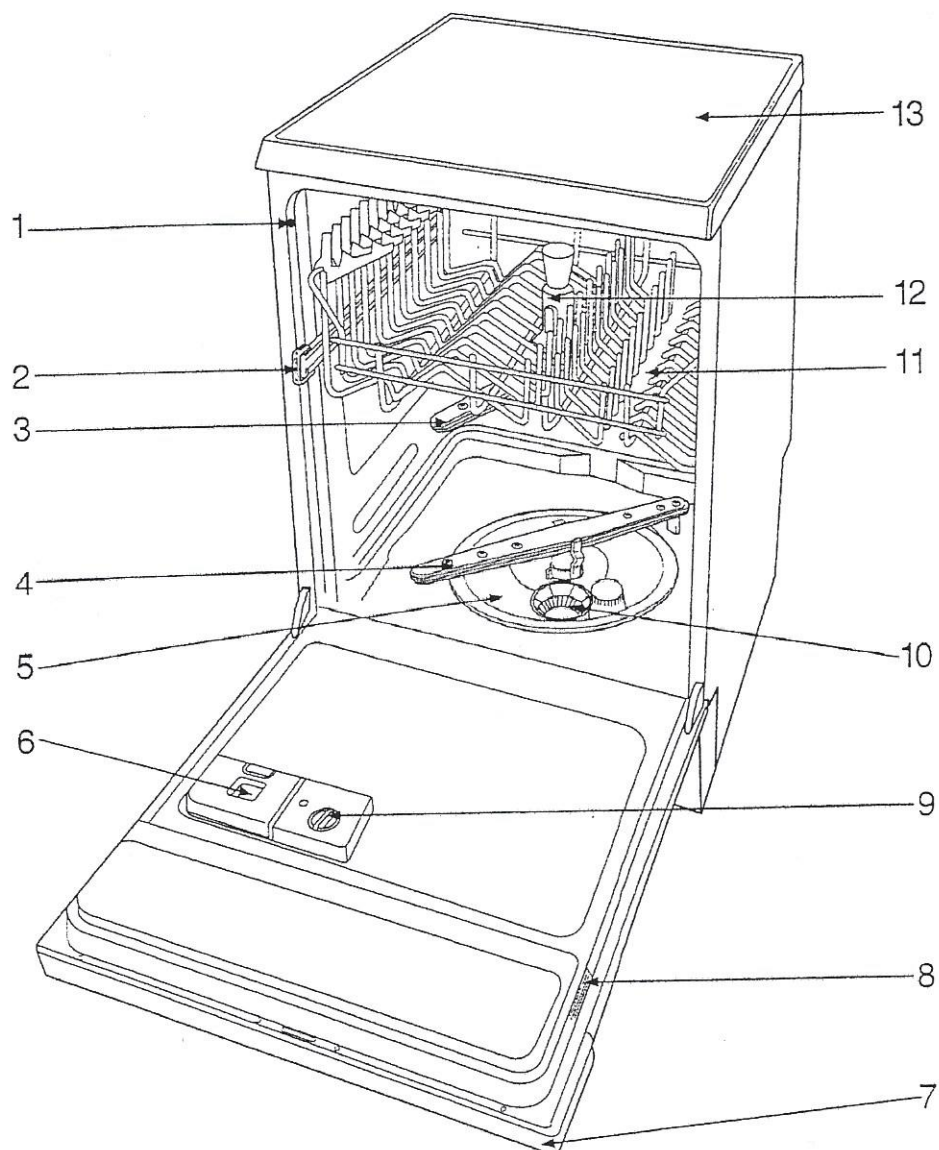

IN63

1. Levelling spacers
2. Upper basket stop
3. Upper spray arm
4. Lower spray arm
5. Large filter
6. Detergent dispenser
7. Control panel
8. Rating plate
9. Rinse aid dispenser

10. Central filters
11. Upper basket
12. Water inlet funnel
13. Worktop

The control panel

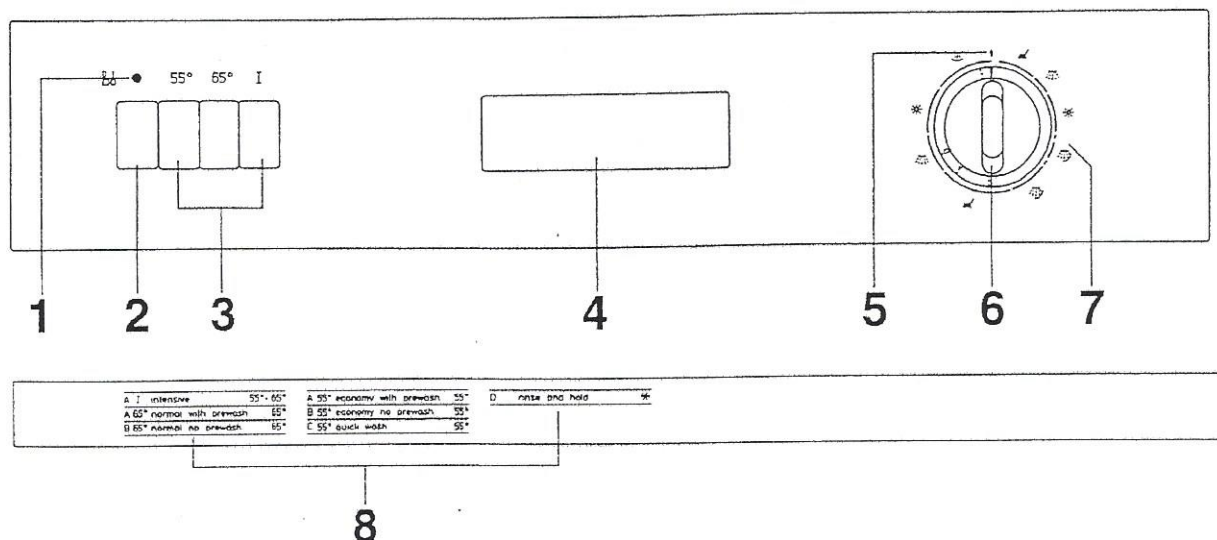

1. On/Off indicator light

2. On/Off pushbutton

On

By depressing this button the machine starts operating and, at the same time the On/Off indicator light illuminates.

Off

When the washing programme has finished, the machine stops automatically and the indicator light remains on.

To switch the indicator light off or to stop the machine at any time, press this button.

3. Washing temperature selection buttons

These buttons allow you to select the temperature of the washing water (see "Washing programmes" chart).

4. Door handle

To open the door press the catch in the top of the recess and pull the door toward you at the same time.

To close the door simply push it.

5. Programme marker

6. Programme selector dial

To select a programme turn the programme selector dial clockwise, making sure that the programme letter you wish to select is in line with the programme marker on the control panel.

7. Programme sequence indicator

As the programme progresses, the sequence indicator turns, to show the phase in the wash programme the appliance has reached.

 Prewash / Rinse and Hold

 Wash

 Cold rinse

 Hot rinse

 Hot air drying

8. Programme guide

This is a summary of the "Washing programmes" chart which will help you select the correct programme.

Before use

Before using your dishwasher for the first time:

1. ensure that the electrical and water connections comply with the installation instructions:
2. remove all packaging from inside the appliance
3. fill the rinse aid dispenser

Rinse aid

Rinse aid is automatically added during the last rinse, ensuring through rinsing, spot and streak free drying. The dispenser, which is positioned inside the door, holds about 110 ml of rinse aid, which is sufficient for 16 - 40 dishwashing programmes, depending upon the dosage setting.

Filling with Rinse aid:

1. Open the container by turning the lid (A) anticlockwise.
2. Add the rinse aid until the container is completely full (approx. 110 ml). The indicator (B) will be completely dark.
3. Top up the rinse aid when the indicator (B) becomes clear.

Ensure that the lid is closed after every refill.

Do not put liquid detergent in the rinse aid department. Clean up any rinse aid spilt during filling with an absorbent cloth to avoid excess foaming during the next wash.

Adjusting the dose

According to the finish and drying results obtained, adjust the dose of rinse aid by means of the 6 position selector (C) (position 1 minimum dosage, position 6 maximum dosage). (Start from position 3). Gradually increase the dose if there are drops of water or lime spots on the dishes after washing. Reduce it if there are sticky whitish streaks on the dishes.

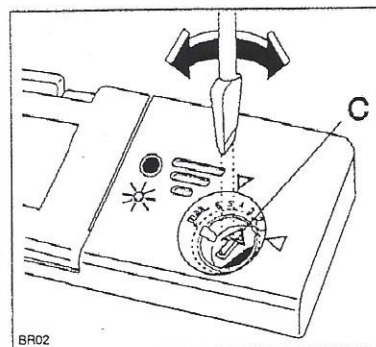
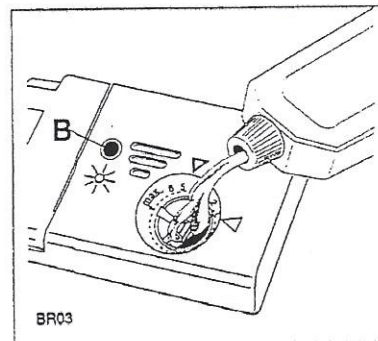
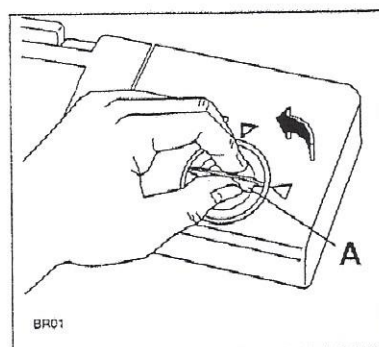

Use of detergent

i Only use detergents specifically designed for use in dishwashers.

To fill the dishwasher with detergent proceed as follows:

1. Open the dispenser lid by pulling the catch (D):
2. Add the detergent according to the recommendations in the programme chart. As all detergents are not the same, you should also consult the instructions on the packet specially for tablets.

To help correctly dose the right amount of detergent, inside the container there are two reference marks:

- MIN = 15 ml
- MAX = 30 ml

3. Always close the lid.
4. If the programme has a prewash add the required detergent over the lid of the dispenser.

Insufficient quantities of detergent will produce poor washing results, whereas an excessive amounts of detergent will not improve washing results and is also wasteful. Using no more than the correct amount also contributes to reducing pollution.

i Check that the detergent receptacle is empty after completion of the wash cycle.

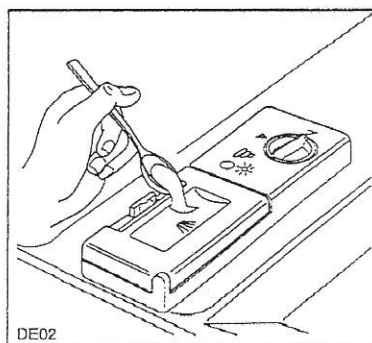
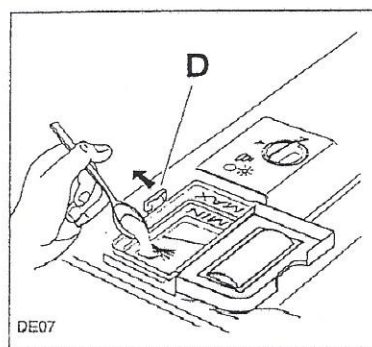

Phosphate free detergents with enzymes

In these low-alkaline compact powders the environment unfriendly components have been replaced by natural enzymes and other more biodegradable substances.

These new compact powders are generally phosphate-free.

Using your appliance

Loading your appliance

Before placing dishes in the machine, remove any scraps of food, to avoid clogging the filters and consequently reducing the performance.

i Do not load very small items which can fall through the baskets.

Open the door and slide out the baskets to load the dishes.

The lower basket

The lower basket is designed to take saucepans, lids, plates (up to 27 cm in diameter), salad bowls, cutlery etc.

Serving dishes and large lids should be arranged around the edge of the basket, ensuring that the upper spray arm can turn freely.

The two rear rows of prongs on the lower basket can be easily lowered to allow you to load pots, pans and bowls.

To lower the prongs:

- Slightly pull them upward and let them drop down (see picture).
- To bring them back to the standing position, just pull them up again.

The cutlery basket

! Long bladed knives stored in an upright position are a potential hazard.

Long and/or sharp items of cutlery such as carvings knives must be positioned horizontally in the upper basket.

Take care when loading or unloading sharp items such as knives.

Cutlery should be placed in the removable cutlery basket with the handles facing downwards. If the handles protrude from the bottom of the basket, obstructing the lower spray arm, load the cutlery with the handles facing upwards.

Mix spoons with other cutlery to prevent them from sticking together.

Silver cutlery tends to go black if mixed with steel cutlery. Place it in the cutlery basket separate from the others.

Arrange the spoons, dessert spoons, knives and other small items of cutlery in the racks on both sides of the cutlery basket.

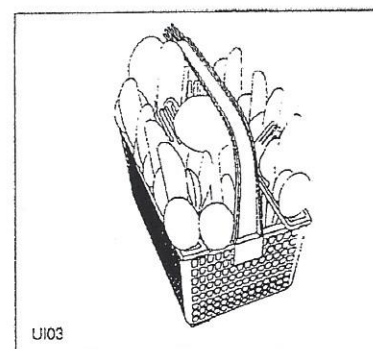
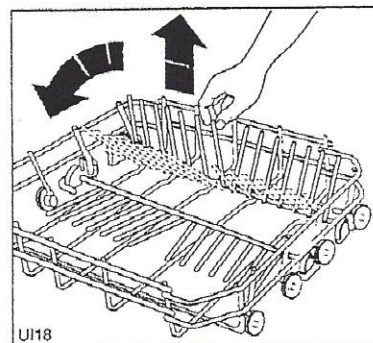
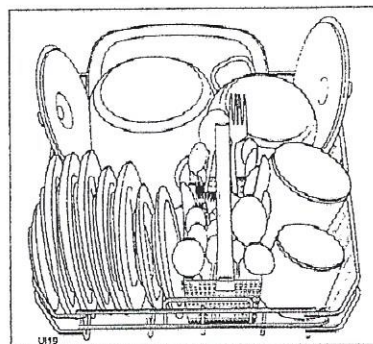
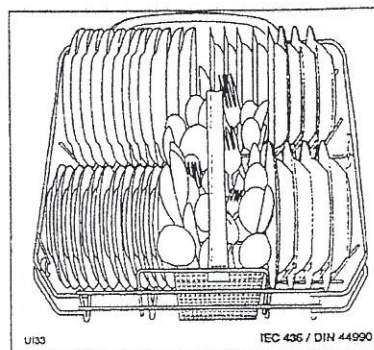

The upper basket

The upper basket is designed for plates (dessert plates, saucers, dinner plates of up to 24 cm in diameter), salad bowls, cups and glasses.

Glasses with long stems can be placed upside down in the raised cup racks.

Light items (plastic bowls etc.) should be loaded in the upper basket and arranged so they do not move.

i Before closing the door, ensure that the spray arms can rotate freely.

Adjusting the height of the upper basket

If washing very large plates (over 27 cm and up to 31 cm in diameter) you can load them in the lower basket after moving the upper basket.

Never lift or lower the basket on one side only.

To move to the higher position proceed as follows:

1. Pull out the basket until it stops.
2. Carefully lift both sides upwards until the mechanism is engaged and the basket is stable.

i When the top basket is in the higher position it will only take plates up to 20 cm in diameter and you will not be able to use the raised cup racks.

To lower the basket to the original position:

1. Pull out the basket until it stops.
2. Carefully lift both sides upwards and then allow the mechanism to drop back down slowly, keeping hold of it.

i When loading the dishes, ensure that you do not cover the water inlet funnel in the middle of the upper basket.

! After loading your machine always close the door, as an open door can be a hazard.

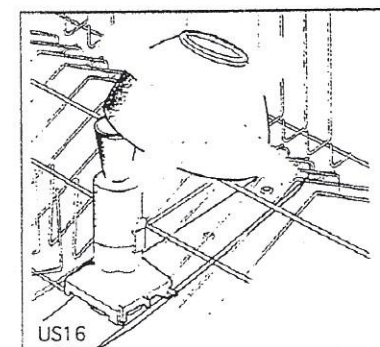
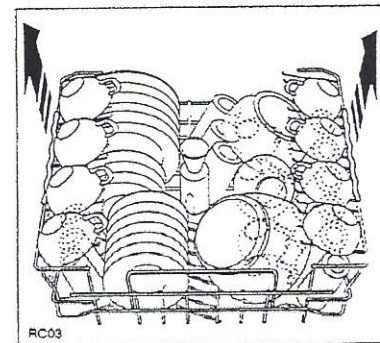
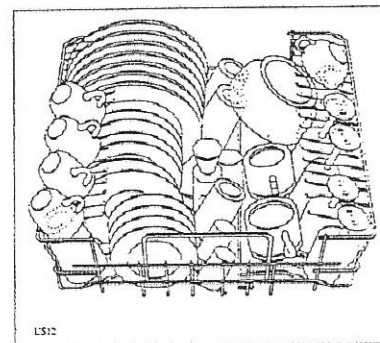
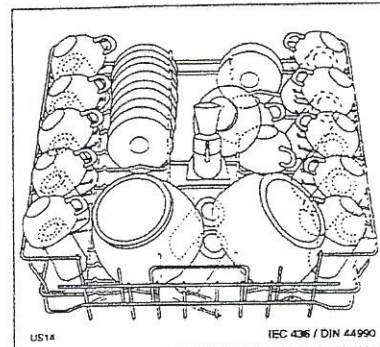

Hints and tips

To save energy

Place dishes in the machine immediately after every meal and wait until the dishwasher is full before washing.

If necessary run the Rinse and Hold programme (see "Washing programmes" chart on the following pages), so that any food scraps do not become caked on the dishes while you are waiting to run the complete wash programme.

Do not prewash dishes under running water.

Select an "Economy" or "Quick" programme when the dishes are not very soiled, following the instructions given in the "Washing programmes" chart.

For best washing results:

Before loading remove all scraps of food and soak very heavily soiled pots and pans.

Arrange saucepans, cups and glasses etc. upside-down.

Tilt items with convex or concave surfaces so that the water drains off easily.

Avoid contact between the dishes as far as possible.

You will improve drying results by leaving the dishwasher door ajar for at least 15-30 minutes as soon as the programme finishes.

Wait a few minutes before removing the dishes; in this way they will be cooler and the drying will be improved.

Empty the lower basket first and then the upper one; this will avoid water dripping from the upper basket onto the dishes in the lower one.

Items not suitable for dishwashers:

The following items should not be washed in the dishwasher (unless they are sold as dishwasher proof):

- Cutlery with wooden or horn handles or glued parts
- bronze cutlery
- saucepans with wooden handles
- aluminium ware
- crystal ware
- leaded glass
- plastic items
- antique or fine decorated china

Certain types of decoration can discolour when washed in a dishwasher.

Crystal-ware and plastic objects, if not guaranteed dishwasher proof should be washed by hand.

Certain types of glass can also become opaque after being washed several times in a dishwasher.

A chemical reaction can occur between silver cutlery and stainless steel cutlery. As a precaution, do not wash together.

Iron and cast iron objects can rust and stain other items.

Aluminium tends to go black, copper, pewter and brass tend to stain.



If in doubt check with manufacturer of the item.



When buying new dishes, ensure that they are dishwasher proof.

Washing programmes

Programme	Degree of soil and type of load	Starting position of the programmer	Required pushbuttons		Recommended quantity of detergent		Cycle description
					in the dispenser	on the dispenser lid	
intensive 65°	Heavy soil. Crockery, cutlery pots and pans	A	I	On Off	25 g	10 g	Hot prewash Main wash up to 65°C 2 cold rinses 1 hot rinse Thermal dry
normal with prewash 65°	Normal soil. Crockery, cutlery pots and pans	A	65°	On Off	25 g	5 g	Cold prewash Main wash up to 65°C 1 cold rinse 1 hot rinse Thermal dry
normal no prewash 65°	Light soil. Crockery and cutlery	B	65°	On Off	25 g	/	Main wash up to 65°C 1 cold rinse 1 hot rinse Thermal dry
economy with prewash 55°	Normal soil. Crockery and cutlery	A	55°	On Off	25 g	5 g	Cold prewash Main wash 55°C 1 cold rinse 1 hot rinse Thermal dry
economy no prewash 55°	Light soil. Crockery and cutlery	B	55°	On Off	25 g	/	Main wash up to 55°C 1 cold rinse 1 hot rinse Thermal dry
* quick wash 55°	Light soil. Crockery and party crockery	C	55°	On Off	25 g	/	Main wash up to 55°C 1 cold rinse 1 hot rinse
rinse and hold	Any. Partial load (to be completed later in the day).	D		On Off	/	/	1 cold rinse (to avoid food scraps from sticking to dishes).

* This is a special programme for quick washing (approx. 50 minutes) a full load of lightly soiled dishes, glasses and crockery (except pots) so that you may re-use them promptly.

Operating sequence

1. Check the filters

Ensure they are clean and properly positioned (see cleaning instructions).

2. Check that there is rinse aid

3. Load the dishes

Remove any scraps of food.

Pull the lower basket out and arrange the saucepans, plates and cutlery in it.

Pull the upper basket out and arrange the plates, saucers, glasses and cups etc. in it. Slide the basket back into the machine.

4. Ensure that the spray arms can rotate freely.

5. Measure out detergent

Add the required amount of detergent into the dispenser according to the "Washing programmes" chart and close the lid.

6. Close the detergent dispenser lid

7. Close the dishwasher door

8. Set the programme

Turn the programme selector dial clockwise until the letter of the programme you wish to select corresponds with the programme marker.

If necessary select the temperature of the main wash according to the instructions in the "Washing programmes" chart (see "Required pushbuttons").

9. Start the programme

Depress the On/Off button.

The On/Off indicator light will come on and the machine will start.

If you wish to interrupt the wash programme at any time press the button again.

10. At the end of the washing programme

At the end of the washing programme the machine stops automatically.

The On/Off indicator light remains on until the On/Off button is depressed.

11. Switch off the dishwasher

Switch off the dishwasher by pressing the On/Off button and open the door.

 When the wash programme has finished, it is recommended that the dishwasher is unplugged and the water tap turned off.

 In general it is not advisable to open the door while the machine is working; if the door is opened however, a safety device ensures that the machine stops.

 **Caution**
Do not open the door during the hot phase: this may cause hot water escape.

 **Care must be taken if the door is opened during the hot phase or immediately after a programme has finished, as steam may escape.**

Maintenance and cleaning

Internal cleaning

Ensure that the seals around the door, the detergent and rinse aid dispensers are cleaned regularly with a damp cloth.

We recommend you carry out a maintenance wash every three months, by running a 65°C programme without dishes using detergent.

Cleaning the central filters

(after each wash)

Inspect the central filters (B) and (C) and remove any scraps of food with a brush, under running water.

Filters (B) and (C) are both removed by lifting up the outer one (B) (pulling the central funnel upwards); the smaller filter (C) can be removed by pressing the two tongues (D).

Once cleaned, refit the filters by pressing them down until they click into place.

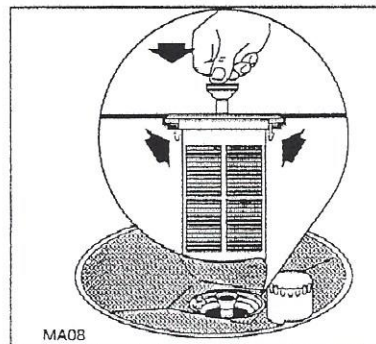
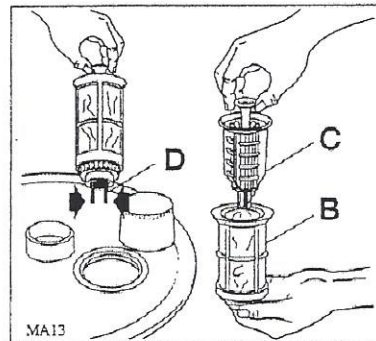

Cleaning the large filter

(Once a month)

Clean the large filter (A) on both sides under running water, using a brush.

To take it out, remove the spray arm by pressing the two tongues (E), turn the ring (F) anticlockwise and then slide the whole part out. Refit the filter following the above instructions in reverse order.

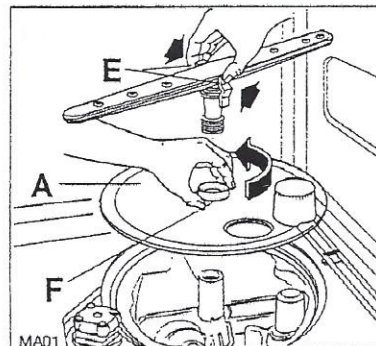

i The dishwasher must not be used without filters.

Incorrect repositioning and fitting of the filters will produce poor washing results.

Cleaning the filters is vital to ensure correct operation of the machine.

External cleaning

Clean the external surfaces of the machine and control panel with a damp soft cloth. If necessary use only neutral detergents. Never use abrasive products, scouring pads or solvent (acetone, trichloroethylene etc....).

Prolonged periods of non-operation

If you are not using the machine for any period of time you are advised to:

1. Unplug the appliance and then turn off the water;
2. Fill the rinse aid dispenser;
3. Leave the door ajar to prevent the formation of any unpleasant smells;
4. Leave the inside of the machine clean.

Frost precautions

Avoid placing the machine in a location where the temperature is below 0°C. If this is unavoidable, empty the machine, close the appliance door, disconnect the water inlet pipe and empty it.

Moving the machine

If you have to move the machine (moving house etc...):

1. Unplug it;
2. Turn the water tap off;
3. Remove the water inlet and discharge;
4. Pull the machine out together with the hoses.

Avoid over tilting the machine during transport.

Something not working

Certain problems are due to lack of simple maintenance or oversights, which can be solved easily without calling out an engineer. Before contacting your local Service Force Centre, please carry out the checks listed below.

Symptom	Solution
The machine will not start	<ul style="list-style-type: none"> ■ The door has not been properly closed. ■ The plug is not properly inserted in the power socket. ■ There is not current at the socket.
The dishwasher does not fill with water	<ul style="list-style-type: none"> ■ Ensure the water tap is open. ■ Ensure the mains water supply has not been cut off. ■ The inlet hose may be squashed or bent. Reposition the hose. ■ The inlet hose may be blocked. Switch off the water supply, and clean the filter.
The filters are blocked	<ul style="list-style-type: none"> ■ Clean the filters (refer to "Maintenance and cleaning").
The spray arms are not rotating	<ul style="list-style-type: none"> ■ Ensure the crockery is loaded correctly.
The dishwasher will not drain	<ul style="list-style-type: none"> ■ The drain hose may be squashed or bent. Reposition the hose. ■ The sink may be blocked. Clear any blockages. ■ The drain hose extension is not correct. Follow the instructions for connecting to the waste. ■ There is no vent in the end of the drain hose.
The machine is noisy	<ul style="list-style-type: none"> ■ Dishes are rattling against each other, (refer to "Loading your machine"). ■ The spray arms are knocking against the dishes.
The door is difficult to close	<ul style="list-style-type: none"> ■ The dishwasher is not level, or not properly built-in.
The dishes are not clean (poor wash)	<ul style="list-style-type: none"> ■ The baskets are too full. ■ The dishes have not been arranged properly. ■ The water inlet funnel in the centre of the upper basket is covered by dishes. ■ The spray arms do not rotate. ■ The spray arms are clogged. ■ The filters are clogged. ■ The filters are not in position. ■ Not enough detergent has been used or it is unsuitable. ■ The detergent is old or has gone hard. ■ The washing programme selected is too gentle.
The dishes are not quite dry	<ul style="list-style-type: none"> ■ The rinse aid has run out or too little is being used.

If after all these checks, the problem persists, contact your local Service Force Centre, quoting the model and serial number. This information can be found on the rating plate located on the right hand side of the dishwasher door (see picture).

Service and spare parts

i This product should be serviced by an authorised Service engineer, and only genuine spare parts should be used. Under no circumstances should you attempt to repair the machine yourself. Repairs carried out by inexperienced persons may cause injury or serious malfunctioning. Contact your local Service Force Centre.

Always insist on genuine spare parts.

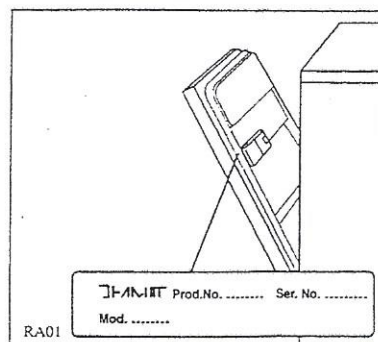

Installation instruction

 Any electrical work required to install this appliance should be carried out by a qualified electrician or competent person.

 Any plumbing work required to install this appliance should be carried out by a qualified plumber or competent person.

Technical specifications

DIMENSIONS	Width	59.6 cm
	Height with worktop	84.7 cm
	Height without worktop	81.7 cm
	Max depth	60 cm
	Max depth with open door	115.2 cm
ELECTRICAL CONNECTION MOTOR RATING DURING WASH POWER OF HEATING ELEMENT OVERALL POWER	Voltage	220-240 V - 50 Hz
		200 W
		1900 W
		2100 W
WATER SUPPLY PRESSURE	Minimum	50 kPa (0.5 bar)
	Maximum	800 kPa (8 bar)
CAPACITY PLACE SETTINGS		12
CONSUMPTION	Water	20 l
	Electricity	1.5 kW/h

Water supply connections

This dishwasher may be fed with either hot (max. 60°C) or cold water.

Nevertheless we advise you a cold water supply.

A hot water supply is not always efficient with very soiled crockery as it shortens the washing programmes a lot.

The water pressure must be within the limits given in the technical specifications.

Your local Water Authority will advise you on the average mains pressure in your area.

The dishwasher features fill and drain hoses which can be turned either to the left or the right to suit the installation.

The locknut must be correctly fitted to avoid water leaks.

Avoid bends or kinks in the hose which could prevent or slow down the water supply.

If the machine is connected to new pipes or pipes which have not been used for a long time, you should run the water for a few minutes before connecting the inlet hose. This will prevent deposits of sand or rust clogging the inlet hose filter.

Be sure to incorporate the filter (A) supplied with the machine onto the joint.

For making the connection itself, the coupling nut fitted to the machine's supply hose is designed to screw onto either a 3/4 inch gas thread spout, or to a purpose made quick-coupling tap such as the Press-block.

To make this easier, the hose itself may be turned to the left or the right.

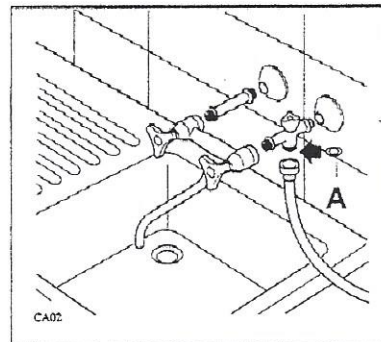

Water outlet hose connection

The end of the drain hose can be connected in the following ways:

1. To the sink outlet siphon, securing it if necessary with a clip.
2. Hooked over the edge of the sink using the special curved plastic guide provided.
3. To a stand pipe provided with vent-hole, minimum internal diameter 4 cm.

The waste connection must be at a height of between 30 cm (minimum) and 100 cm (maximum) from the bottom of the dishwasher.

The drain hose can face either to the right or left of the dishwasher

Ensure the hose is not bent or squashed as this could prevent or slow down the discharge of water. If you use a drain hose extension it must be no longer than 2 metres and its internal diameter must be no smaller than the diameter of the hose provided.

Likewise the internal diameter of the couplings used for connections to the waste outlet must be no smaller than the diameter of the hose provided.

The sink plug must not be in place when the machine is draining as this could cause the water to siphon back into the machine.

Electrical connection

Before plugging the appliance into the wall socket, make sure that:

1. The mains voltage corresponds to the voltage given in the "Technical specifications".
2. The meter, fuses, mains power supply and wall socket can all take the maximum load required.

Make sure that the socket and plug are compatible without having to use any type of adaptor. If necessary, have the domestic wiring system socket replaced.

Safety standards require the appliance to be earthed.

The manufacture accepts no liability for failure to observe the above safety precautions.

CE This appliance complies with the following E.E.C. Directives:
- 73/23 of 19.2.73 (Low Voltage Directive) and subsequent modifications;
- 89/336 of 3.5.89 (Electromagnetic Compatibility Directive) and subsequent modifications.

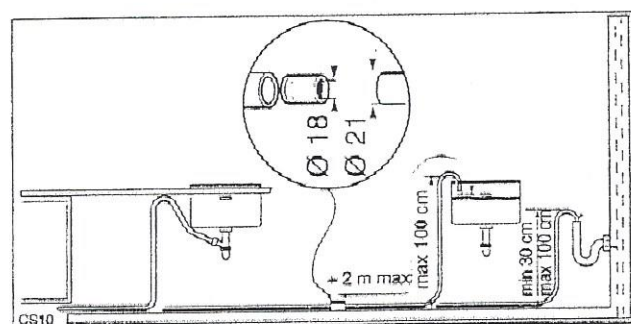
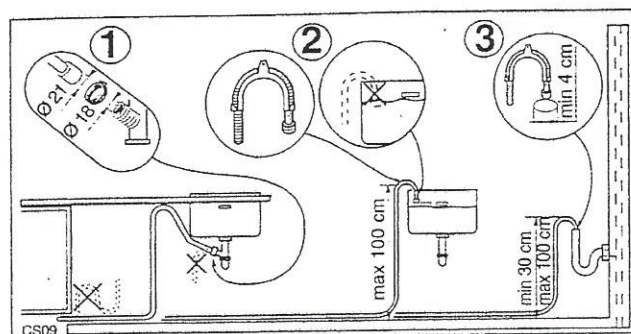

Adjusting the worktop

You can move the worktop forward or backward by 25 mm in order to align the machine with other kitchen units.

Simply unscrew the two rear retaining screws, move the top to the required position and then retighten the screws.

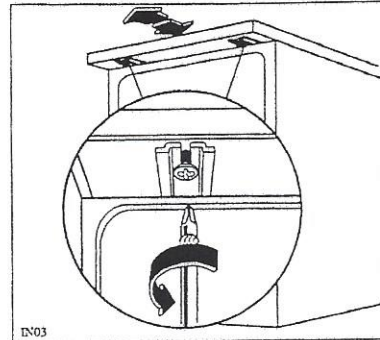

Fitting under a counter (kitchen worktop or sink)

By removing the machine's worktop, you can install it under a close fitting sink unit or a pre-existing top, providing the dimensions of the recess correspond to those shown in the picture.

Proceed as follows:

Remove the machine's worktop by unscrewing the two rear retaining screws, pull from the front and slide out the rear slots, lifting the worktop.

Insert the machine after adjusting the height and levelling with the adjustable feet. When inserting the machine, ensure that the water inlet and drain hoses are not kinked or squashed.

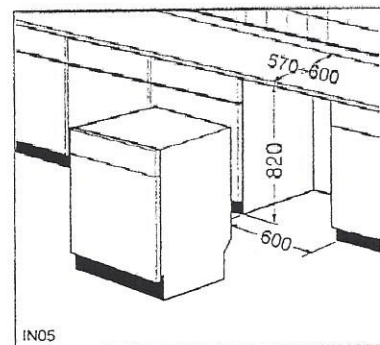

Levelling

Good levelling is essential for correct closure and sealing of the door.

When the appliance is correctly levelled, the door will not catch on the levelling spacers, either side of the cabinet.

If the door does not close correctly, loosen or tighten the adjustable feet until the machine is perfectly level.

Fitting a decor panel on the door

The door of this machine has frames for fitting a plastic laminate decor panel in the colour required to match the dishwasher with the rest of the kitchen furnitur.

If you wish to do this you must provide the panel yourself, that must have the following dimensions:

Width: 588 mm

Height: 586 mm

Max thickness: 4 mm

To fit the panel

Take the door frame off after removing the retaining screws around the edge.

Position the panel, refit the frame and tighten the retaining screws around the edge.

Note:

The panel should be fitted before positioning the machine.

